

## IMPORTANT SAFETY RULES

Read, understand, and follow all instructions carefully before installing and using this product. Keep for future reference.

# DISC SWING KIT

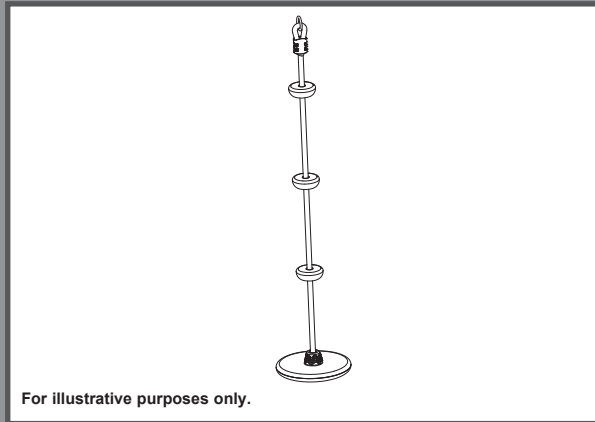

For illustrative purposes only.

Don't forget to try these other fine Intex products: pools, pool accessories, inflatable pools and in-home toys, airbeds and boats available at fine retailers or visit our website.

Due to a policy of continuous product improvement, Intex reserves the right to change specifications and appearance, which may result in updates to the instruction manual without notice.

OWNER'S MANUAL

**INTEX**<sup>®</sup>

©2025 Intex Marketing Ltd. - Intex Development Co. Ltd. - Intex Recreation Corp. All rights reserved/Tous droits réservés/Todos los derechos reservados/Alle Rechte vorbehalten. Printed in China/Imprimé en Chine/Impreso en China/Gedruckt in China.

<sup>®</sup>™ Trademarks used in some countries of the world under license from/<sup>®</sup>™ Marques utilisées dans certains pays sous licence de/Marcas registradas utilizadas en algunos países del mundo bajo licencia de/Warenzeichen verwendet in einigen Ländern der Welt in Lizenz von/Intex Marketing Ltd. to/à/a/an Intex Development Co. Ltd., Hong Kong & Intex Recreation Corp., P.O. Box 1440, Long Beach, CA 90801 • Distributed in the European Union by/Distribué dans l'Union Européenne par/Distribuido en la unión Europea por/Vertrieb in der Europäischen Union durch/Intex Trading B.V., Ettenseweg 46, 4706 PB Roosendaal – The Netherlands • Distributed in the UK by Unitex Service (UK) Limited, 124 City Road, London, England, EC1V 2NX, UK.

www.intexcorp.com

376-<sup>\*</sup>A<sup>\*</sup>-R0-2608

## TABLE OF CONTENTS

<b>Warning</b> .....	<b>3</b>
<b>Playground surfacing information</b> .....	<b>4</b>
<b>Parts reference</b> .....	<b>5</b>
<b>Set up</b> .....	<b>5-6</b>
<b>Assembly preparation</b> .....	<b>5-6</b>
<b>Installation</b> .....	<b>7</b>
<b>Maintenance</b> .....	<b>8</b>
<b>Warranty</b> .....	<b>9</b>

**SAVE THESE INSTRUCTIONS**

# IMPORTANT SAFETY RULES

**376  
A**

Observing the following statements and warnings reduces the likelihood of serious or fatal injury. Review these safety rules regularly with your children.

## READ AND FOLLOW ALL INSTRUCTIONS



## WARNING

- This product is intended for standing or sitting use.
- To be installed on A-frame swing sets only with quick hooks or carabiners rated for a maximum weight of 150 kg (330 lbs). Do not install on tree branches.
- Before you assemble this product, find a level ground site with at least 2 m (6 ft) of clearance from any structure or obstruction. This product must have 2 m (6 ft) clearance on all sides.
- This product is for family domestic outdoor use only. Not designed for use in day care, nurseries, commercial or other public places.
- Continuous and competent adult supervision of children is required at all times when on or around this product. Never leave children unattended.
- This product is designed for use by children from ages 3 to 10 years under adult supervision. Children under 10 years have a higher risk of entrapment and injury.
- The maximum number of users this product is designed for is one child with a maximum weight of 50 kg (110 lbs).
- Do not exceed the intended weight limit or maximum number of users for this product.
- Only for domestic use. This product is to be assembled and disassembled by adults only.
- Ensure the legs of the A-frame swing set are anchored into the ground.
- To prevent serious injury, do not allow children to use this product until it is completely assembled and properly anchored.
- Do not install home playground equipment over concrete, asphalt or any other hard surface. The product should be installed over impact absorbing surfaces such as sand, wood-bark chips, rubber and foam. See "Playground Surfacing Information" section for detail.
- Warn children not to walk close to, in front of, behind, or between moving items.
- Do not allow children to twist swing chains or ropes or loop them over the top support bar since this may reduce the strength of the chain or rope.
- Never add extra length to chain or rope. The chains or ropes provided are the maximum length designed for the swinging element(s).
- Do not allow children to swing empty seats or swings.
- Teach and instruct children to sit or stand in the center of the swing with their full weight on the swing.
- Closely assist children with use of this product until they have adequate strength, skills and comfort level for safe use without assistance.
- Do not allow children to use this product in a manner other than intended.
- Warn children not to get off the swings or rides while they are in motion.
- Ensure children are dressed appropriately. Wearing loose-fitting shoes and clothing such as scarfs and ponchos are potentially hazardous while using this product.
- Product may become slippery when wet or during bad weather, such as rain, snow, ice, etc. Do not allow children to use this product under such conditions.
- Verify that suspended swing and chains are secured at both ends and cannot be looped back on themselves.
- Do not allow children to attach any items to this product that are not specifically designed for use with the equipment, such as, but not limited to, jump ropes, clotheslines, pet leashes, cables and chain as they may cause a strangulation hazard.
- Warn children to remove their bike or other sports helmet before using this product.
- Do not allow children to swing too high or at an angle.
- Do not allow children to hang or climb from any structural members of this product.
- Do not modify this product and/or use accessories not supplied by the manufacturer.

**FAILURE TO FOLLOW THESE WARNINGS MAY RESULT IN PROPERTY DAMAGE, SERIOUS INJURY OR DEATH.**

## SAVE THESE INSTRUCTIONS

## Playground Surfacing Information

### Consumer information sheet for playground surfacing materials

The US Consumer Product Safety Commission (CPSC) estimates that about 100 000 playground equipment-related injuries resulting from falls to the ground surface are treated annually in US hospital emergency rooms. Injuries involving this hazard pattern tend to be among the most serious of all playground injuries, and have the potential to be fatal, particularly when the injury is to the head. The surface under and around playground equipment can be a major factor in determining the injury-causing potential of a fall. It is self-evident that a fall on to a shock-absorbing surface is less likely to cause a serious injury than a fall onto a hard surface. Playground equipment should never be placed on hard surfaces, such as concrete or asphalt, and while grass may appear to be acceptable, it may quickly turn to hard-packed earth in areas of high traffic. Shredded bark mulch, wood chips, fine sand or fine gravel are considered to be acceptable shock absorbing surfaces when installed and maintained at a sufficient depth under and around playground equipment.

Table 1 lists the maximum height from which a child would not be expected to sustain a life-threatening head injury in a fall on to four different loose-fill surfacing materials if they are installed and maintained at depths of 150 mm, 225 mm and 300 mm.

**Table 1 — Fall height in millimetres from which a life-threatening head injury would not be expected**

Type of material	Depth of surfacing material		
	150 mm	225 mm	300 mm
Double shredded bark mulch	1 800	3 000	3 300
Wood chips	1 800	2 100	3 600
Fine sand	1 500	1 500	2 700
Fine gravel	1 800	2 100	3 000

However, it should be recognized that all injuries due to falls cannot be prevented, no matter what surfacing material is used.

It is recommended that a shock absorbing material extend a minimum of 1 800 mm in all directions from the perimeter of stationary equipment such as climbing frames and slides. However, because children may deliberately jump from a moving swing, the shock absorbing material should extend in the front and rear of a swing a minimum distance of twice the height of the pivot point measured from a point directly beneath the pivot on the supporting structure.

This information is intended to assist in comparing the relative shock-absorbing properties of various materials. No particular material is recommended over another. However, each material is only effective when properly maintained. Materials should be checked periodically and replenished to maintain correct depth as determined necessary for the equipment in question. The choice of a material depends on the type and height of the playground equipment, the availability of the material in a particular area, and its cost.

This information has been extracted from the CPSC publications *"Playground Surfacing — Technical Information Guide"* and *"Handbook for Public Playground Safety"*.

## SAVE THESE INSTRUCTIONS

## PARTS REFERENCE

**376**  
**A**

Before assembling your product, please take a few minutes to check the contents and become familiar with all the parts.

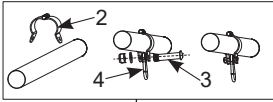

REF. NO.	DESCRIPTION	QTY.	PART NO.
1	Disc swing kit	1	12894
2	Clamp	1	13603
3	Bolt set	1	13600
4	Quick hook	1	13601

**NOTE:** Drawings for illustration purpose only. Not to scale.

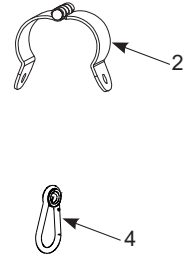
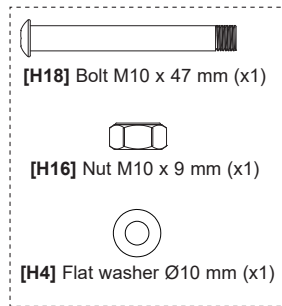
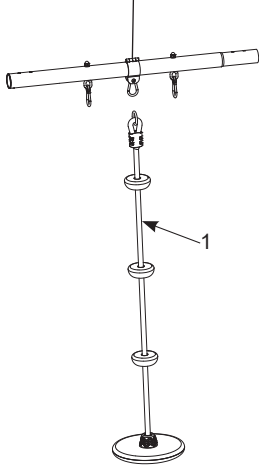

## SET UP

### Site preparation and requirements

- Place the product on level ground, with at least a 2 m (6 ft) space from any structure or obstruction such as a fence, garage, house, overhanging branches, laundry lines, lamp post, or electrical wires.
- Create a site free of obstacle that could cause injuries – such as tree stumps and/or roots, bricks, rocks, sprinkler heads and concrete.
- Swings should be further away from structures to the front and rear of the swings – a distance equal to twice the height of the top bar from which the swing is suspended.

## ASSEMBLY PREPARATION

### Selecting the Swing Set final location

- The area where the Swing Set is to be set up must be absolutely flat and level. Do not set up the product on a slope or inclined surface.
- In addition to the 2 m (6') minimum horizontal clearance space all around the set, your site must have a minimum of 4 m (13') of vertical ground clearance. This height requirement requires 2 m (6') of vertical clearance above the top of the Swing Set.

## SAVE THESE INSTRUCTIONS

# SET UP (continued)

376  
A

### General Information:

- The maximum number of users this product is designed for is one child with a maximum weight of 50 kg (110 lbs).
- Maximum Fall Height: 1.92 m (6'3.5").
- Ensure the A-frame swing set structure can support an additional 150 kg (330 lbs) weight.
- Attach the disc swing to an A-frame swing set horizontal beam by removing one existing set of chain swing.
- Ensure safe distance from other objects on either side of the disc swing: more than 0.45m (1'5.7").
- Install the disc swing so that the lowest point is not less than 0.35 m (1'2") off the ground.
- Ensure the legs of the A-frame swing set are anchored into the ground.

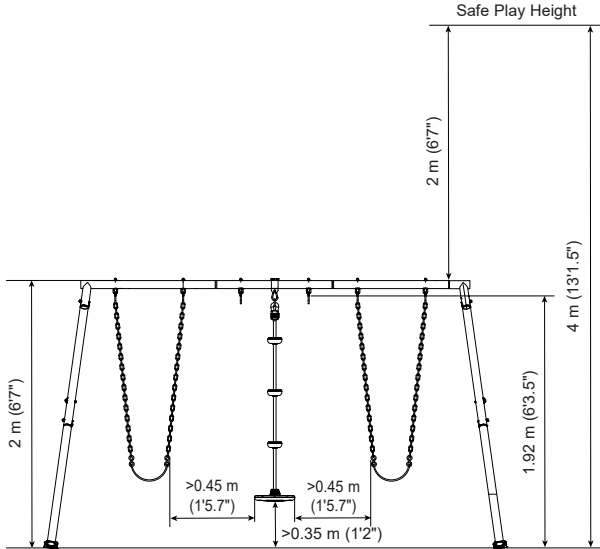

**NOTE:** A-frame swing set and other swing accessories are not included, and are shown here for assembly purposes only.

### Tools required for installation:

One (1) wrench and one (1) hexagon key (included tools).

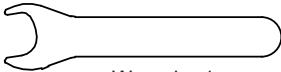

Wrench x1  
(included)

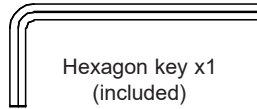

Hexagon key x1  
(included)

## SAVE THESE INSTRUCTIONS

## INSTALLATION

1. Attach the clamp (2) to the center of horizontal beam between the two empty quick hooks.

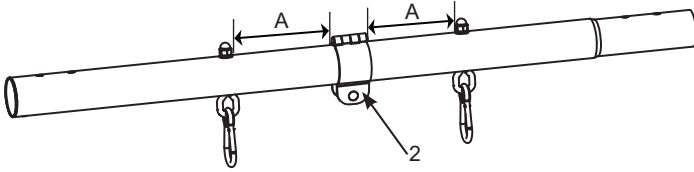

2. Place the quick hook (4) with the small end inside the clamp (2), insert the bolt through the clamp (2) and the quick hook (4). Tighten the bolt and nut with the wrench and hexagon key. **NOTE:** make sure the clamp is centered between the two empty quick hooks, and the bolt and nut are securely tightened.

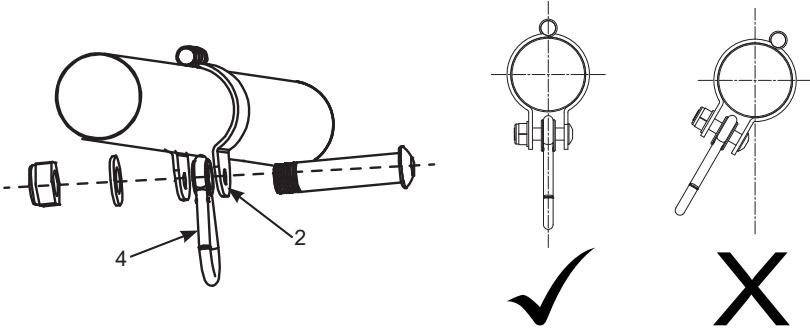

3. Hang the disc swing kit to the A-frame swing set horizontally beam quick hook.

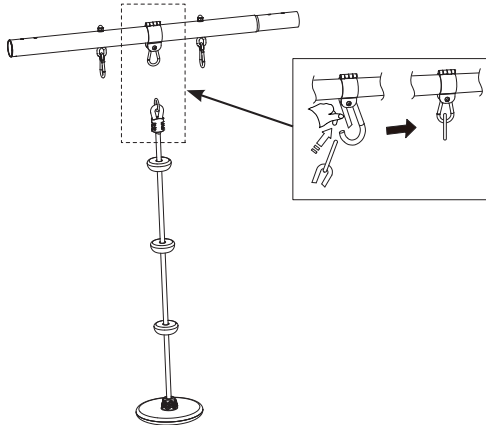

**SAVE THESE INSTRUCTIONS**

## MAINTENANCE

376  
A

### **IT IS IMPORTANT TO CHECK AND TIGHTEN ALL HARDWARE AT THE BEGINNING AND DURING THE SEASON.**

#### **At the beginning of each play season:**

- Lubricate all metallic moving parts.
- Check that the disc swing is securely connected to the horizontal beam. Tighten as needed.
- Check all protective coverings on bolts, pipes, edges, and corners. Replace if they are loose, cracked, or missing.
- Check all moving parts including swing seats, ropes, cables, and chains for wear, rust, or other deterioration. Replace as needed.
- Check metal parts for rust. If found, sand and repaint using a nonlead-based paint meeting the requirements of 16 CFR 1303.
- Reinstall any plastic parts, such as swing seats or any other items that were removed for the cold season.
- Rake and check depth of loose fill protective surfacing materials to prevent compaction and to maintain appropriate depth. Replace as necessary.

#### **Twice a month during play season:**

- Check that the disc swing is securely connected to the horizontal beam. Tighten as needed.
- Check all protective coverings on bolts, pipes, edges, and corners. Replace if they are loose, cracked, or missing.
- Rake and check depth of loose fill protective surfacing materials to prevent compaction and to maintain appropriate depth. Replace as necessary.

#### **Once a month during play season:**

- Check all moving parts including swing seats, ropes, cables, and chains for wear, rust, or other deterioration. Replace as needed.

#### **At the end of each season or when the temperature drops below 0° C (32° F)**

- Remove all plastic swing parts and take indoors or do not use.
- Rake and check depth of loose fill protective surfacing materials to prevent compaction and to maintain appropriate depth. Replace as necessary.

#### **Owners shall be responsible for maintaining the legibility of the warning labels.**

#### **Disposal instructions:**

- Disassemble and dispose of the playground equipment in such a way that no unreasonable hazards will exist at the time the equipment is discarded. Follow all local disposal requirements.
- Fully disassemble the entire frame. Do not leave partially disassembled parts in areas accessible by children.
- Should you wish to recycle the steel tubing, take the frame to your local recycling center.
- All plastic parts can be recycled, take it to your local recycling center.
- Do not let children play with any disassembled parts meant for disposal, such as chains, tubing, bolts, nuts, screws, ropes, etc.
- All rusted parts, bolts must be properly disposed of. Do not reuse them.

Save this instruction and information sheet in the event that the manufacturer has to be contacted.

## SAVE THESE INSTRUCTIONS

## LIMITED WARRANTY

**376  
A**

Your Intex Disc Swing Kit has been manufactured using the highest quality materials and workmanship. All Intex products have been inspected and found free of defects prior to leaving the factory. This Limited Warranty applies to the Intex Disc Swing Kit only.

This limited warranty is in addition to, and not a substitute for, your legal rights and remedies. To the extent that this warranty is inconsistent with any of your legal rights, they take priority. For example, consumer laws across the European Union provide statutory warranty rights in addition to the coverage you receive from this limited warranty: for information on EU-wide consumer laws, please visit the European Consumer Center website at [http://ec.europa.eu/consumers/ecc/contact\\_en/htm](http://ec.europa.eu/consumers/ecc/contact_en/htm).

The provisions of this limited warranty apply only to the original purchaser and are not transferable. This limited warranty is valid for the period noted below from the latter of the date of the initial retail purchase or delivery. Keep your original sales receipt with this document, as proof of purchase will be required and must accompany warranty claims or the limited warranty will be invalid.

### Disc Swing Kit Warranty – 2 Years

If you find a manufacturing defect in the Disc Swing Kit during the warranty periods noted above, please contact the appropriate Intex Service Center listed in the separate "Authorized Service Centers" sheet. If the item is returned as directed by the Intex Service Center, the Service Center will inspect the item and determine the validity of the claim. If the item is covered by the provisions of the warranty, the item will be repaired or replaced, with the same or comparable item (at Intex's choice) at no charge to you.

Other than this warranty, and other legal rights in your country, no further warranties are implied. To the extent possibly in your country, in no event shall Intex be liable to you or any third party for direct or consequential damages arising out of the use of your Intex Disc Swing Kit, or Intex or its agents' and employees' actions (including the manufacture of the product). If your country does not allow the exclusion or limitation of incidental or consequential damages, this limitation or exclusion does not apply to you.

You should note that this limited warranty does not apply in the following circumstances:

- If the Intex Disc Swing Kit is subject to negligence, abnormal use or application, accident, improper operation, improper maintenance or storage;
- If the Intex Disc Swing Kit is subject to damage by circumstances beyond Intex's control, including but not limited to, ordinary wear and tear and damage caused by exposure to fire, flood, freezing, rain, or other external environmental forces;
- To parts and components not sold by Intex; and/or.
- To unauthorized alterations, repairs or disassembly to the Intex Disc Swing Kit by anyone other than Intex Service Center personnel.

Injury or damage to any property or person is not covered by this warranty.

Read the owner's manual carefully and follow all instructions regarding proper operation and maintenance of your Disc Swing Kit. Always inspect your product prior to use. This limited warranty will be void if use instructions are not followed.

## SAVE THESE INSTRUCTIONS