

IMPORTANT SAFETY RULES

Please read, understand, and follow all instructions carefully before installing and using this product.

LED Pool-Wall Light

Model WL698

100–240V, 50/60Hz

Emitter: IP66, Receiver: IP68 ($\frac{\nabla}{1.2\text{ m}}$)



For illustrative purposes only.

Don't forget to try these other fine Intex products: pools, pool accessories, inflatable pools and in-home toys, airbeds and boats available at fine retailers or visit our website.

Due to a policy of continuous product improvement, Intex reserves the right to change specifications and appearance, which may result in updates to the instruction manual without notice.

INTEX®

©2023 Intex Marketing Ltd. - Intex Development Co. Ltd. - Intex Recreation Corp.
All rights reserved/Tous droits réservés/Todos los derechos reservados/Alle Rechte vorbehalten. Printed in China/Imprimé en Chine/Impreso en China/ Gedruckt in China.

®™ Trademarks used in some countries of the world under license from/®™ Marques utilisées dans certains pays sous licence de/Marcas registradas utilizadas en algunos países del mundo bajo licencia de/Warenzeichen verwendet in einigen Ländern der Welt in Lizenz von/Intex Marketing Ltd. to/à/a/an Intex Development Co. Ltd., Hong Kong & Intex Recreation Corp., P.O. Box 1440, Long Beach, CA 90801 • Distributed in the European Union by/Distribué dans l'Union Européenne par/Distribuido en la unión Europea por/Vertrieb in der Europäischen Union durch/Intex Trading B.V., Ettenseweg 46, 4706 PB Roosendaal – The Netherlands • Distributed in the UK by Unitex Service (UK) Limited, 21 Holborn Viaduct, London EC1A 2DY, UK.

www.intexcorp.com

155-A*-R0-2407

TABLE OF CONTENTS

Warnings	3
Parts References	4
Setup Instructions	5-6
Installation on Intex Graphite Gray Panel™ Pools	6
Operation Instructions	6
Troubleshooting Guide	7
Long Term Storage	8
General Aquatic Safety	8
Limited Warranty	9

SAVE THESE INSTRUCTIONS

Page 2

IMPORTANT SAFETY RULES

Read, Understand and Follow All Instructions Carefully Before Installing and Using this Product.

READ AND FOLLOW ALL INSTRUCTIONS



WARNING

- To reduce the risk of electric shock, do not open this product.
- To reduce the risk of injury, do not permit children to use this product. Always supervise children and those with disabilities.
- Children must stay away from this product and electrical cord(s).
- Assembly and disassembly by adults only.
- Risk of electric shock. Connect this product only to a grounding type receptacle protected by a ground-fault circuit interrupter (GFCI) or residual current device (RCD). Contact a qualified electrician if you cannot verify that the receptacle is protected by a GFCI/RCD. Use a qualified electrician to install the GFCI/RCD, which has a maximum rate of 30mA. Do not use a portable residual current device (PRCD).
- Always unplug this product from the electrical outlet before removing, cleaning, servicing or making any adjustment to the product.
- The supply cord cannot be replaced. If the cord is damaged the appliance should be scrapped.
- The plug must be accessible after product is installed.
- To reduce the risk of electric shock, do not use extension cords, timers, plug adaptors or converter plugs to connect unit to electric supply; provide a properly located outlet.
- Do not immerse the transformer and the external transmitter unit into water.
- Do not bury the electrical cord. Locate the cord where it will not be damaged by lawn mowers, hedge trimmers and other equipment.
- Do not attempt to plug in or unplug this product while standing in water or when your hands are wet.
- Do not throw or drop the product.
- Do not stare directly at the light emitted by this product.
- Do not operate the product if transmitter housing or pool light lens is cracked or showing water leakage; remove from pool or water immediately.
- Do not insert fingers or objects into the openings and holes.
- Strong magnets. Keep this device away from mobile phone and other electronic gadgets.
- Keep the transformer more than 3.5m away from the pool.
- Keep the plug of this product more than 3.5m away from the pool.
- This product is for use with storable pools only. Do not use with permanently installed pools. A storable pool is constructed so that it may be readily disassembled for storage and reassembled to its original configuration.
- This product is intended to be used only for the purposes described in the manual!

FAILURE TO FOLLOW THESE WARNINGS MAY RESULT IN PROPERTY DAMAGE, ELECTRIC SHOCK, ENTANGLEMENT OR OTHER SERIOUS INJURY OR DEATH.

These product warnings, instructions and safety rules provided with the product represent some common risks of water recreation devices and do not cover all instances of risk and danger. Please use common sense and good judgement when enjoying any water activity.

SAVE THESE INSTRUCTIONS

PARTS REFERENCES

Before assembling your product, please take a few minutes to check the contents and become familiar with all the parts.

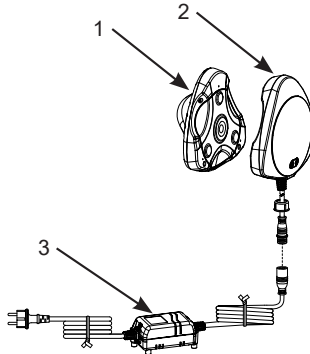

NOTE: Drawings for illustration purpose only. Actual product may vary. Not to scale.

REF. NO.	DESCRIPTION	QTY.	SPARE PARTS NO.
1	POOL LIGHT	1	12731
2	TRANSMITTER	1	12727
3	TRANSFORMER	1	12729

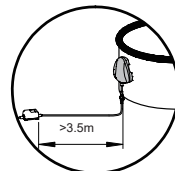
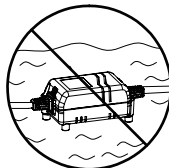
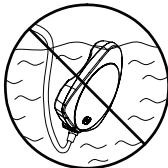
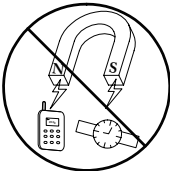
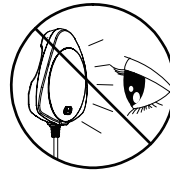
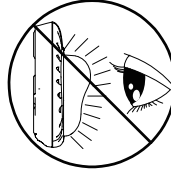
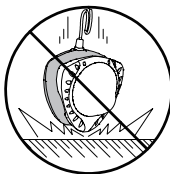
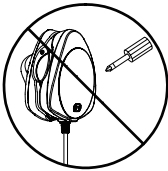

SAVE THESE INSTRUCTIONS

SETUP INSTRUCTIONS

155
A

This product is specially designed for above ground pool. The LED pool-wall light uses magnetic technology to create a light system that safely generates low voltage current through the pool's sidewall to a powerful LED light inside the pool.

⚠ WARNING

- Always unplug this product from the electrical outlet before removing, cleaning, servicing or making any adjustment to the product.
- Do not operate the product if transmitter housing or pool light lens is cracked or showing water leakage; remove from pool or water immediately.
- Never place the power transmitter in water.

IMPORTANT

- This product is for use with above ground non-steel wall pools with a thickness of 1mm (0.04 in) or less.
- Do not use this product as a free standing light.

1. Separate the pool light (1) from the transmitter (2) by hand through the side opening groove. **See drawings (1 & 2).**

CAUTION: To avoid finger pinch or injury, always separate the pool light from the transmitter through the side opening groove.

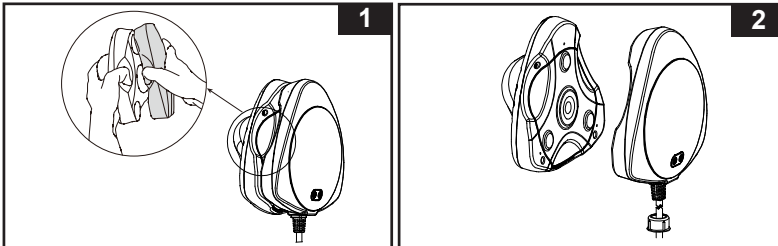

2. Place the transmitter (2) on the outside of the pool wall and the pool light (1) on the inside of the pool wall submerged in water. Ensure the transmitter magnetic poles are properly aligned with the magnetic poles on the pool light unit. **See drawing (3).**

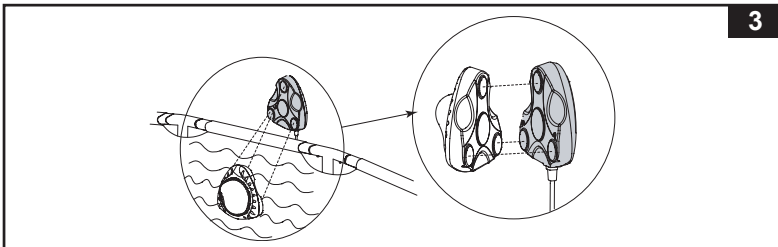

SAVE THESE INSTRUCTIONS

SETUP INSTRUCTIONS (continued)

155
A

- 3. Adjust the position of the pool light by manually sliding the transmitter position sideways and/or vertically.
- 4. Plug the assembled unit to an electrical outlet protected by a ground-fault circuit interrupter (GFCI).

Installation on Intex Graphite Gray Panel™ Pools:

Unscrew the bolts from the section where the LED pool-wall light will be installed, and remove the clamp covers, the top board and the side boards. Refer to the Panel Pool owner's manual for details. For better installation, it is recommended to remove at least 3 side board panels. Follow above setup instructions 1 to 4.

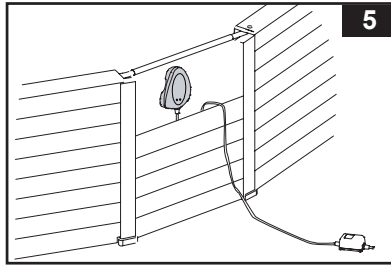
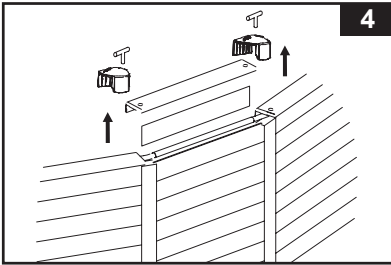

OPERATION INSTRUCTIONS

Press the Left / Right button to select the light mode and color.

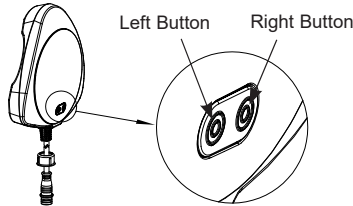

- **Left button:** turn the pool light ON and OFF, and sets the light mode.



Press left button	Once	Twice	3 times
Color	Soft white	OFF	Color changing

- **Right button:** turn the transmitter light ON and OFF, and sets the light mode.

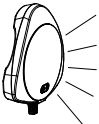

Press right button	Once	Twice	3 times	4 times	5 times	6 times	7 times
Color	Soft white	Green	Teal	Blue	Purple	Color changing	OFF

Note: When the transmitter light is on, press and hold right button for 3 seconds to turn off the light.

SAVE THESE INSTRUCTIONS

TROUBLESHOOTING GUIDE

PROBLEM	CAUSE	SOLUTION
DIFFICULT TO ALIGN THE POOL LIGHT AND THE TRANSMITTER	<ul style="list-style-type: none"> Wrong orientation, magnetic poles are not aligned correctly. 	<ul style="list-style-type: none"> Rearrange the orientation of the pool light and the transmitter. See "setup instructions".
THE LED POOL-WALL LIGHT DOES NOT LIGHT UP	<ul style="list-style-type: none"> The power cord is loose. 	<ul style="list-style-type: none"> Plug the cord firmly into the electrical outlet. Tighten the intermediate connection between the transmitter and the transformer.
	<ul style="list-style-type: none"> The GFCI is tripped. 	<ul style="list-style-type: none"> Contact Intex Service Center.
	<ul style="list-style-type: none"> Wrong orientation and alignment between the pool light and the transmitter. 	<ul style="list-style-type: none"> Rearrange the orientation of the pool light and the transmitter. See "setup instructions".
	<ul style="list-style-type: none"> Water inside pool light unit. Possible transmitter or transformer failure. 	<ul style="list-style-type: none"> Contact Intex Service Center.
THE POOL LIGHT UNIT DOES NOT FLOAT	<ul style="list-style-type: none"> Water inside the pool light unit. 	<ul style="list-style-type: none"> Contact Intex Service Center.

IMPORTANT

If you continue to experience difficulty, please contact our Consumer Service Department for assistance. See separate "Authorized Service Centers" sheet.

SAVE THESE INSTRUCTIONS

LONG TERM STORAGE

In areas where freezing temperatures occur, there is risk of ice damage to the product. It is recommended to remove, clean and store the product in a safe place when temperature drops below 0 degrees Celsius (32 degrees Fahrenheit).

1. Unplug the power cord from the electrical socket.
2. Remove the transmitter (2) from the outside of the pool wall first, the pool light (1) unit will automatically float to the surface for easy retrieval, then remove the pool light from the water.
IMPORTANT: To prevent damage to the transmitter from falling to the ground, always remove the transmitter first before removing the pool light unit.
3. If deposits or debris are seen inside the holes of the pool light, use a garden hose to flush them out. Do not scrape the pool-wall light or use brush to clean it.
4. Thoroughly air-dry all components before storage.
5. Store the product and accessories in a dry, temperature controlled location between 32 degrees Fahrenheit (0 degrees Celsius) and 104 degrees Fahrenheit (40 degrees Celsius).
6. The original packaging can be used for storage.

GENERAL AQUATIC SAFETY

Water recreation is both fun and therapeutic. However, it involves inherent risks of injury and death. To reduce your risk of injury, read and follow all product, package and package insert warnings and instructions. Remember, however, that product warnings, instructions and safety guidelines cover some common risks of water recreation, but do not cover all risks and or dangers.

For additional safeguards, also familiarize yourself with the following general guidelines as well as guidelines provided by nationally recognized Safety Organizations:

- Demand constant supervision. A competent adult should be appointed as a "life guard" or water watcher, especially when children are in and around the pool.
- Learn to swim.
- Take the time to learn CPR and first aid.
- Instruct anyone who is supervising pool users about potential pool hazards and about the use of protective devices such as locked doors, barriers, etc.
- Instruct all pool users, including children what to do in case of an emergency.
- Always use common sense and good judgement when enjoying any water activity.
- Supervise, supervise, supervise.

SAVE THESE INSTRUCTIONS

LIMITED WARRANTY

**155
A**

Your LED Pool-Wall Light has been manufactured using the highest quality materials and workmanship. All Intex products have been inspected and found free of defects prior to leaving the factory. This Limited Warranty applies only to the LED Pool-Wall Light.

This limited warranty is in addition to, and not a substitute for, your legal rights and remedies. To the extent that this warranty is inconsistent with any of your legal rights, they take priority. For example, consumer laws across the European Union provide statutory warranty rights in addition to the coverage you receive from this limited warranty: for information on EU-wide consumer laws, please visit the European Consumer Center website at http://ec.europa.eu/consumers/ecc/contact_en/htm.

The provisions of this Limited Warranty apply only to the original purchaser and are not transferable. This Limited Warranty is valid for a period of one (1) year from the date of the initial retail purchase. Keep your original sales receipt with this document, as proof of purchase will be required and must accompany warranty claims or the Limited Warranty will be invalid.

If you find a manufacturing defect in the LED Pool-Wall Light during the warranty period, please contact the appropriate Intex Service Center listed in the separate "Authorized Service Centers" sheet. If the item is returned as directed by the Intex Service Center, the Service Center will inspect the item and determine the validity of the claim. If the item is covered by the provisions of the warranty, the item will be repaired or replaced, with the same or comparable item (at Intex's choice) at no charge to you.

Other than this warranty, and other legal rights in your country, no further warranties are implied. To the extent possibly in your country, in no event shall Intex be liable to you or any third party for direct or consequential damages arising out of the use of your LED Pool-Wall Light, or Intex or its agents' and employees' actions (including the manufacture of the product). If your country does not allow the exclusion or limitation of incidental or consequential damages, this limitation or exclusion does not apply to you.

You should note that this limited warranty does not apply in the following circumstances:

- If the LED Pool-Wall Light is subject to negligence, abnormal use or application, accident, improper operation, improper voltage or current contrary to operating instructions, improper maintenance or storage;
- If the LED Pool-Wall Light is subject to damage by circumstances beyond Intex's control, including but not limited to, ordinary wear and tear and damage caused by exposure to fire, flood, freezing, rain, or other external environmental forces;
- To parts and components not sold by Intex; and/or;
- To unauthorized alterations, repairs or disassembly to the LED Pool-Wall Light by anyone other than Intex Service Center personnel.

The costs associated with the loss of pool water, chemicals or water damage are not covered by this warranty. Injury or damage to any property or person is not covered by this warranty.

Read the owner's manual carefully and follow all instructions regarding proper operation and maintenance of your LED Pool-Wall Light. Always inspect your product prior to use. This limited warranty will be void if use instructions are not followed.

SAVE THESE INSTRUCTIONS