

INTEX® OWNER'S MANUAL

BIMINI TOP SUN SHADE

English

99
IO

READ AND FOLLOW ALL INSTRUCTIONS BEFORE USING THIS PRODUCT



WARNING

- Remove canopy and store properly when not in use or in the presence of strong winds, thunderstorms, heavy rain or snow.
- Never place items on top of canopy or exert excessive force onto the frame when in use.
- Check that all canopy connections are secure prior to entering the boat.
- This product is intended to be used only for the purposes described in the manual.

FAILURE TO FOLLOW THESE WARNINGS AND THE ASSEMBLY AND USE INSTRUCTIONS MAY RESULT IN SERIOUS INJURY, DROWNING OR PROPERTY DAMAGE.

Parts Reference

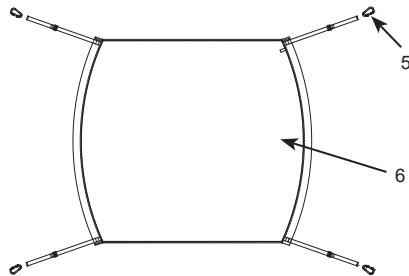
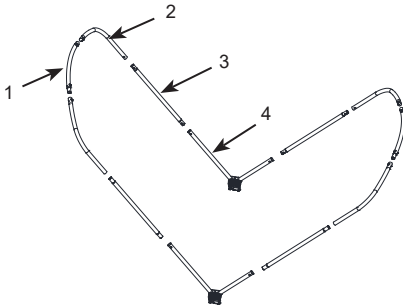

NOTE: Drawings for illustration purpose only. May not reflect actual product. Not to scale.

REF. NO.	DESCRIPTION	QTY.	SPARE PART NO.
1	Crossbar	2	13244
2	J-shaped rod	4	13245
3	Straight rod	4	13246
4	Folding joint with mounting bracket	2	13249
5	Hook	4	13247
6	Canopy	1	13248

©2023 Intex Marketing Ltd. - Intex Development Co. Ltd. - Intex Recreation Corp. All rights reserved/Tous droits réservés/Todos los derechos reservados/Alle Rechte vorbehalten. Printed in China/Imprimé en Chine/Impreso en China/Gedruckt in China.

®™ Trademarks used in some countries of the world under license from®™ Marques utilisées dans certains pays sous licence de/Marcas registradas utilizadas en algunos países del mundo bajo licencia de/Warenzeichen verwendet in einigen Ländern der Welt in Lizenz von/Intex Marketing Ltd. to/a/an Intex Development Co. Ltd., Hong Kong & Intex Recreation Corp., P.O. Box 1440, Long Beach, CA 90801 • Distributed in the European Union by/Distribué dans l'Union Européenne par/Distribuido en la unión Europea por/Vertrieb in der Europäischen Union durch/Intex Trading B.V., Ettenseweg 46, 4706 PB Roosendaal – The Netherlands • Distributed in the UK by Unitec Service (UK) Limited, 21 Holborn Viaduct, London EC1A 2DY, UK.

INTEX®

www.intexcorp.com

SAVE THESE INSTRUCTIONS

General

- No tools are required for the assembly. A team of 2 people is recommended for assembly and disassembly.
- For Intex boat models: MARINER 3 & 4, EXCURSION 4, CHALLENGER 3, and SEAHAWK 3 & 4.
- Make sure the boat is setup and inflated first. The boat must be on dry land when installing the canopy to the boat.
- Stow the canopy when cruising at high speed.
- Never attempt to setup this product during strong winds, thunderstorms, heavy rain or snow.

Setup instructions

1. Frame Assembly

- 1.1 Connect the end of the J-shaped rods (2) marked "A" to the crossbar (1) ends marked "A". Make sure the spring pin is securely snapped into the hole. See Fig 1.

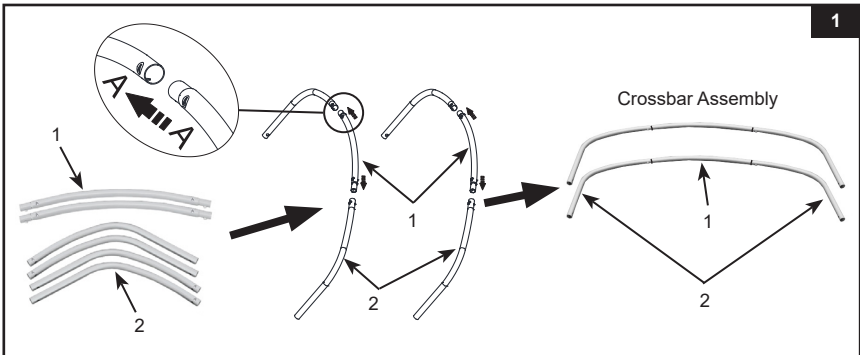

- 1.2 Connect the straight rods (3) to the folding joint with mounting brackets (4). Make sure the spring pin is securely snapped into the hole. See Fig 2.

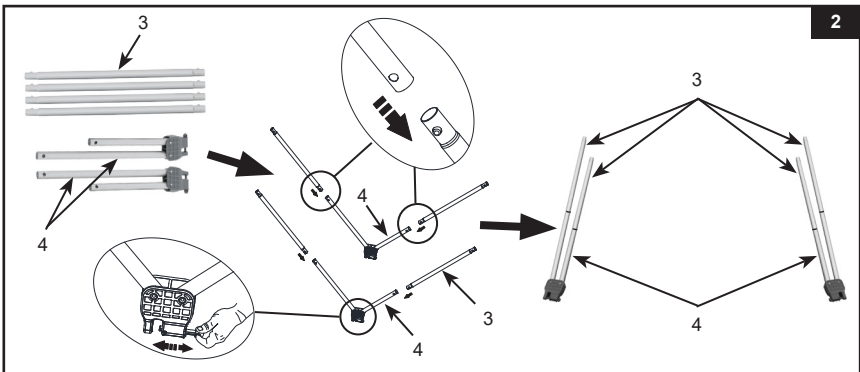

SAVE THESE INSTRUCTIONS

2. Installing the canopy to the frame

- 2.1 Spread out the canopy (6) and slide the crossbar assembly into the canopy sleeve. Repeat this procedure for the other canopy sleeve. Adjust the canopy so that it's centered over the crossbar assembly. See Fig 3.1-3.2.

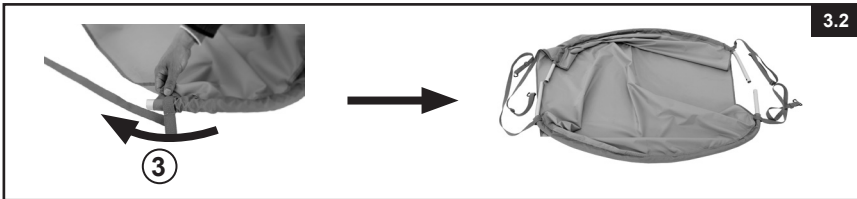
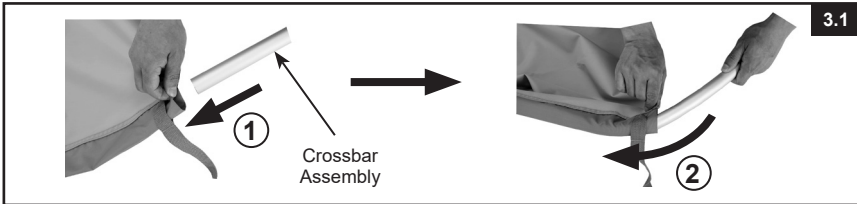

- 2.2 Attach the crossbar assembly with the canopy to the folding joint with mounting bracket assembly. Make sure the spring pin is securely snapped into the hole. **IMPORTANT:** The canopy side with the "black pull tab" must be facing down or inward. See Fig 4.

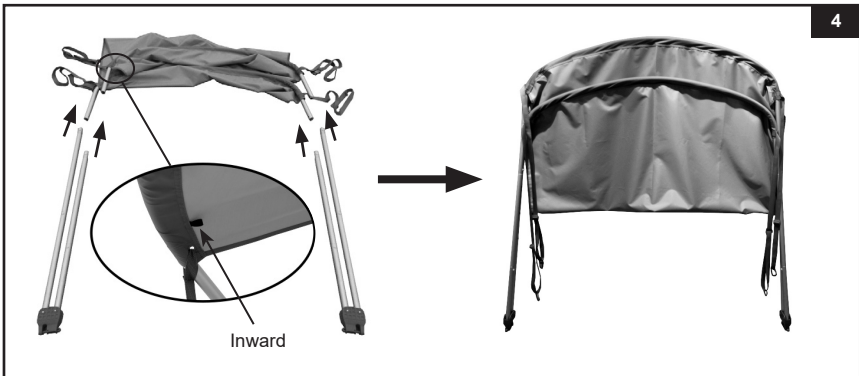

SAVE THESE INSTRUCTIONS

3. Installing the canopy assembly to the boat

- 3.1 For Intex Mariner 3 & 4 models:** locate the rope holders with “double holes” on the sides of the hull near the front of the boat. With the “short” side of the crossbar assembly facing the front of the boat, attached the canopy assembly mounting brackets to the rope holders with double holes. Pull the safety pin first then release the pin so that it’s securely latched onto the rope holder and the mounting bracket. Repeat the process with the other side. See Fig 5.

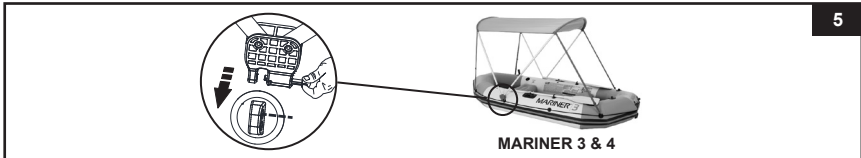

- 3.2 For Intex Excursion 4, Seahawk 3 & 4 and Challenger 3 models:** With the tall side of the crossbar assembly facing the front of the boat, attached the canopy assembly mounting brackets to the oar holders located on the sides of the hull near the back of the boat. Pull the safety pin first then release the pin so that it’s securely latched onto the oar holder and the mounting bracket. Repeat the process with the other side. See Fig 6.



- 3.3** Fasten the 4 hooks located at the end of the canopy straps to the rope holders located on the sides of the hull. Check that the canopy is centered and stretched out. Adjust the straps buckles to tighten the canopy. See Fig 7.

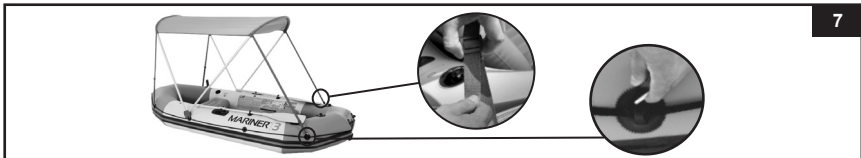

Maintenance and long term storage

1. Regularly check all components for sign of damage, and wear and tear. Replace damaged components immediately.
2. Reverse the above setup instructions to disassemble the canopy.
3. Use a sponge and fresh water to wipe away any soil or stains on the canopy.
4. Make sure all components are completely dry before storage.
5. Store the canopy and accessories in a dry, temperature controlled, between 0° – 40°C (32° – 104°F), storage location.
6. The original packing can be used for storage.

SAVE THESE INSTRUCTIONS